

# REN WOTA

# TANK

# HANBUK



Ce livret est réalisé par l'équipe du projet SCP2 (supporting community planning) de la Croix Rouge du Vanuatu et la Croix Rouge Française, grâce au financement de l'USAID (du Peuple américain).

This booklet is produced by the team of SCP2 (Supporting community planning) project of Vanuatu Red Cross Society and the French Red Cross, with funding from USAID (From the American people).

Buklet ia tim blong SCP2 (Sapotem Komuniti Planing) oli raetem mo mekem folem projek blong Vanuatu Red Cross Society wetem Croix Rouge Française, mo fanding i kam long USAID (from ol pipol blong Amerika).

La Croix Rouge du Vanuatu 2014  
Design & illustrations Litttebylittte pour Alliance française de Port-Vila  
Imprimé à Port-Vila par Classic Printers  
Avec le soutien de l'Alliance française de Port-Vila pour la traduction.

# TEBOL BLONG KONTEN

---

- 1.** OL TUL MO MATERIOL p.4
- 2.** OL DIFREN TAEP BLONG HAOS p.7
- 3.** REDI BLONG WOKEM TANK KONKRIT STAMBA p.8
- 4.** WOKEM FAONDESEN BLONG TANK KONKRIT STAMBA p.9
- 5.** PUTUM GUD OL GATA p.11
- 6.** PUTUM GUD TANK p.13
- 7.** HAO BLONG KIPIM GUD SISTEM BLONG YU p.14

# 1. OL TUL MO MATERIOL

## REDI LO GRAON BLONG TANK

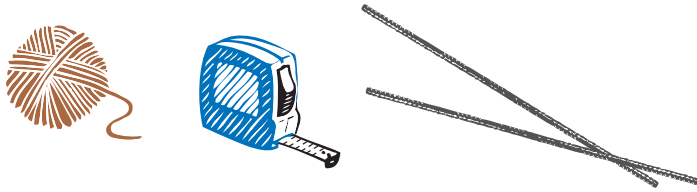

## OL TUL MO MATERIOL BLONG WOKEM FAONDESEN BLONG 110 L TANK KONKRIT STAMBA



## BLONG WAN 1100 LITER TANK :

| Name  | Quantity |
|---|----------|
| <b>FACIA BOARD AND GATA</b>                   |          |
| Facia Board 25mmX200mmX4m                     | 2        |
| PVC Gutter (4m)                               | 2        |
| PVC Gutter Bracket                            | 11       |
| PVC Pipe 100mm (4m)                           | 2        |
| PVC Running Outlet 100mm                      | 1        |
| PVC stop end gutter 100mm                     | 1        |
| PVC gutter joiner 100mm                       | 1        |
| PVC 'T' Join Junction 100mm                   | 1        |
| PVC First Flush Coupling Threaded 100mm       | 1        |
| End Cap Threaded100mm                         | 1        |
| PVC Elbow 90°                                 | 1        |
| Zinith Board Screws to attach gutter brackets | 1 Box    |
| PVC Glue 250ml                                | 1 bottle |
| Pipe Clip 100mm                               | 6        |
| Poly Tank 1,100L                              | 1        |

## TANK KONKRIT STAMBA 1.2m X 1.2m

|                              |                 |
|------------------------------|-----------------|
| Portland Cement 40 kg        | 2 Bags          |
| Reinforcing Rod D10          | 5               |
| Tie Wire                     | 1 Kg            |
| Ply Wood 12mm (for formwork) | 1 Sheet         |
| Local wood for bracing 1m    | 15              |
| Wire nails 3"                | 1kg             |
| Wire nails 2"                | 1kg             |
| Wire nails 4"                | 1kg             |
| Sand                         | 6m <sup>3</sup> |
| Coral                        | 2m <sup>3</sup> |

## OL TUL BLONG SIMENT WOK

|                                      |   |
|--------------------------------------|---|
| Builders line rolls                  | 1 |
| Carpenters lead pencils              | 1 |
| Carpenters Square                    | 1 |
| Crow Bar 1680 x 30mm                 | 1 |
| Hand Saw (crosscut & rip)            | 1 |
| Masonry water level                  | 1 |
| Measuring tape 8m galvanized         | 1 |
| Pliers Flat nose pincer for tie wire | 1 |
| Shovel round mouth                   | 2 |
| Concrete steel finishing float       | 1 |
| Trowel 450mm                         | 1 |
| Wooden Float 112 x 300mm             | 1 |
| Yam Spade                            | 1 |

## MENTENENS TUL



## 2. OL DIFREN TAEP BLONG HAOS

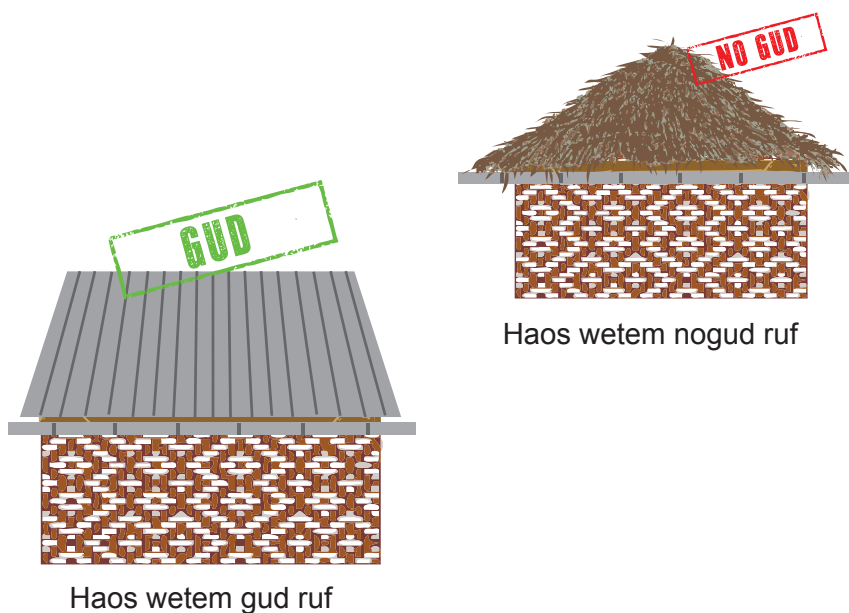
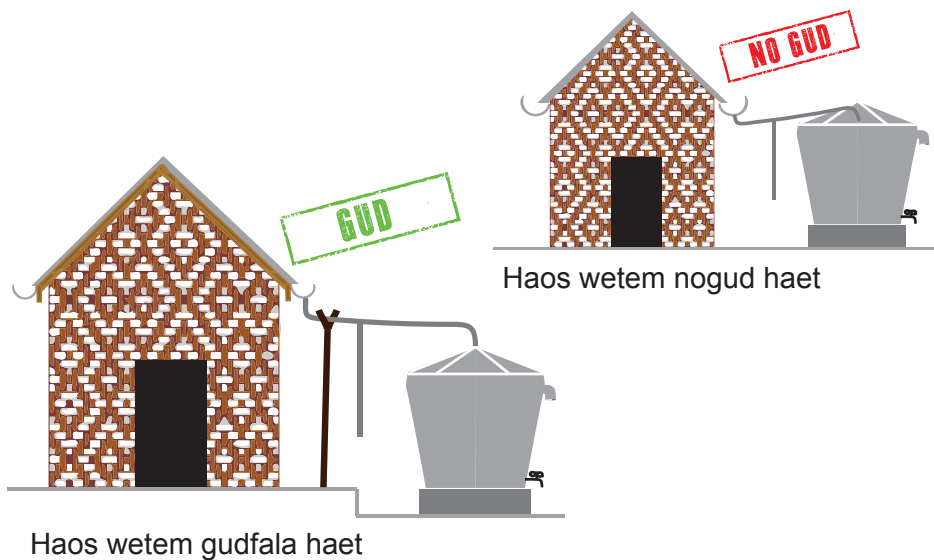

### 3. REDI BLONG WOKEM TANK KONKRIT STAMBA



No dro long finga, usum stik mo string.

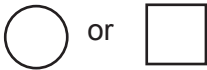
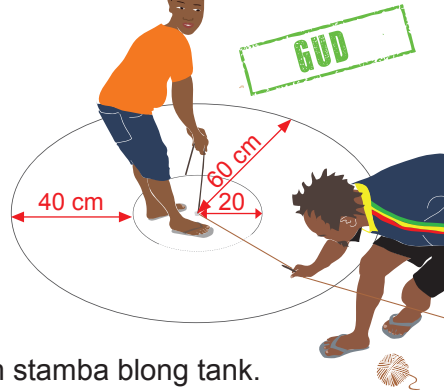

Gudfala wei blong skwerem stamba blong tank.

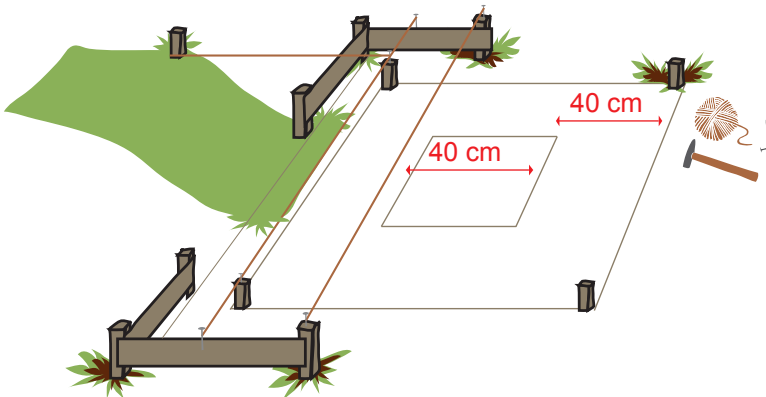



## 4. WOKEM FAONDESEN BLONG TANK KONKRIT STAMBA

Mekem gud boxing blong yu.

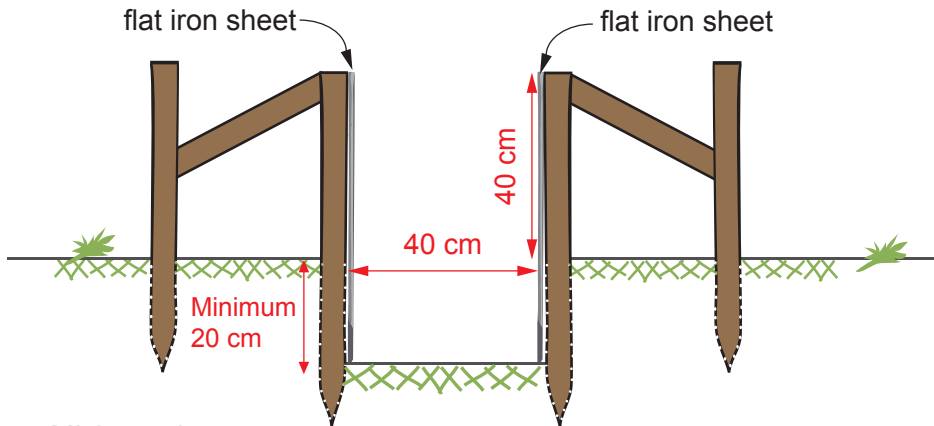

Mixim gud siment blong yu.

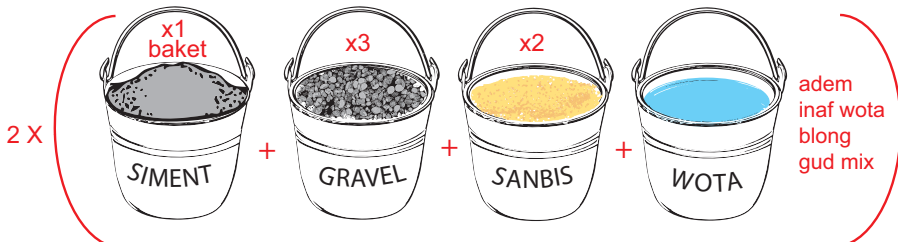

Kapsaedem siment i ko insaed long boxing blong yu, mo lego i drae blong wan dei.

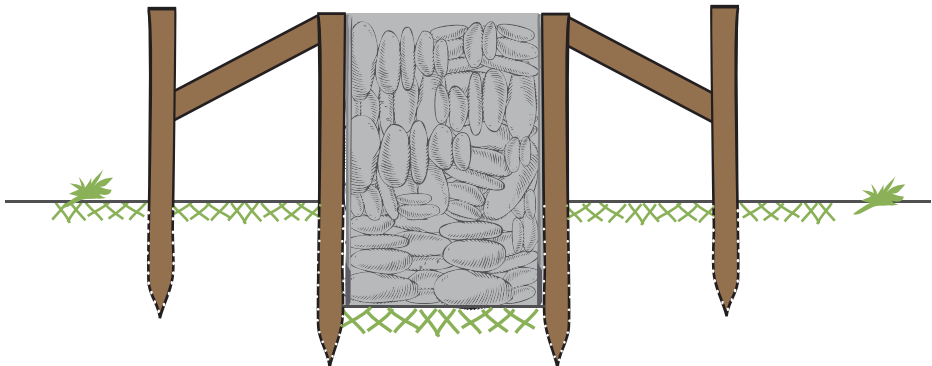

Karemaot boxing long faondesen blong yu.  
Fulumap graon mo ston insaed mo ramem gud.

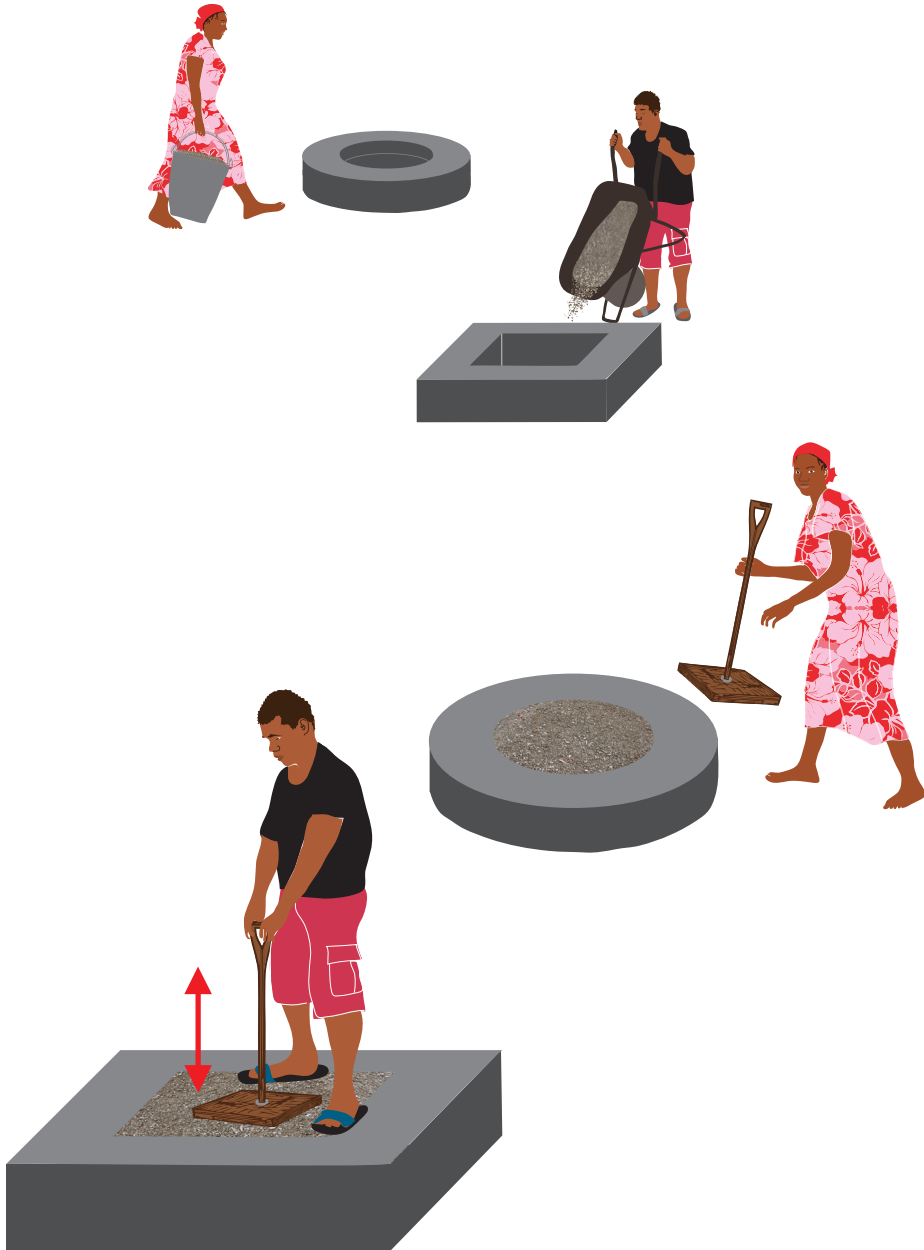

## 5. PUTUM GUD OL GATA

Flat timba long saed blong ruf we bae yu hangem gata blong yu. Putum ol gata braket long evri 40cm. Nilim o skrewem braket i ko long flat timba.

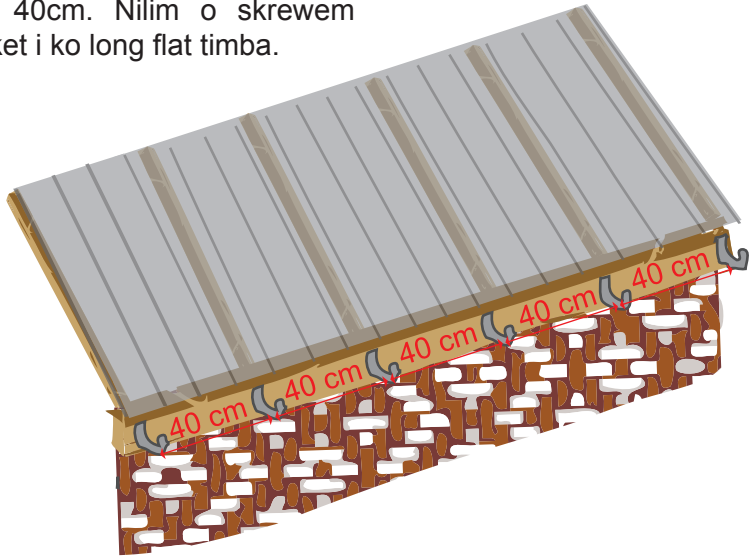

Joinem ol paep wetem glu.

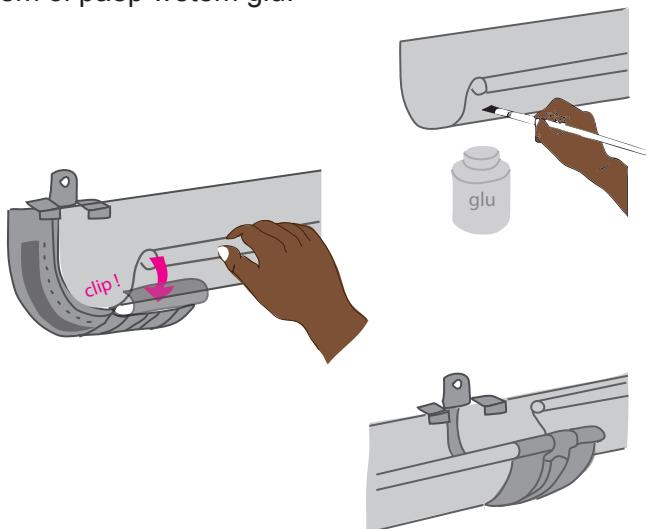

# SISTEM BLONG REN WOTA

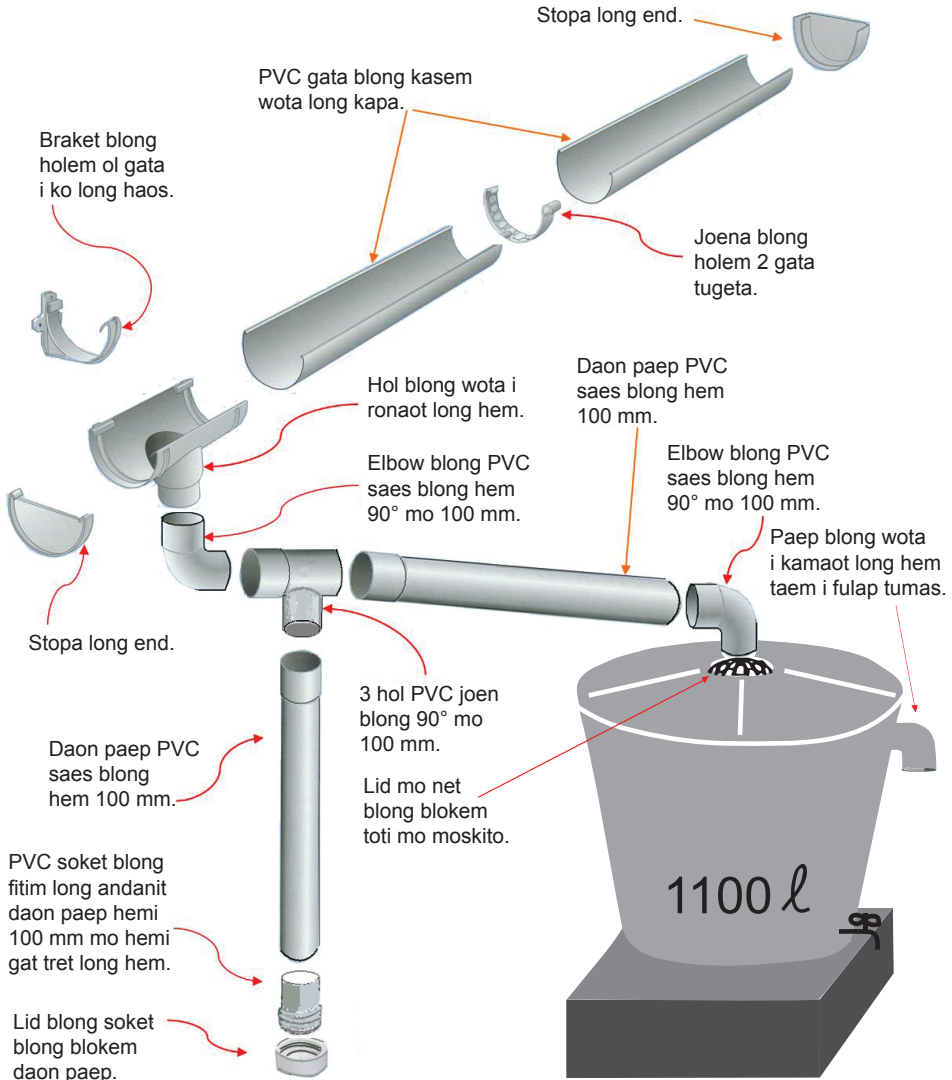

## 6. PUTUM GUD TANK

Taem yu putum tank i ko long stamba blong hem mekem sua se yu no brokem tank, mo mekem tap i ko long wan ples we bae i kat gud drenej.



Digim smol long graon blong drenej.

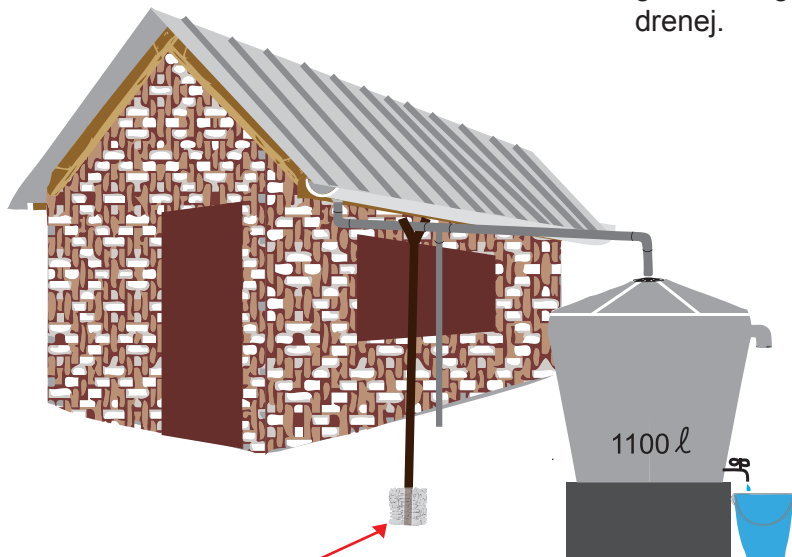

Putum wan kale blong holem paep.

# 7. HAO BLONG KIPIM MO MEKEM GUD SISTEM BLONG YU

Katem ol tri we i stap kolosap long sistem blong yu, blong ol lif oli no ko insaed long tank o gata.

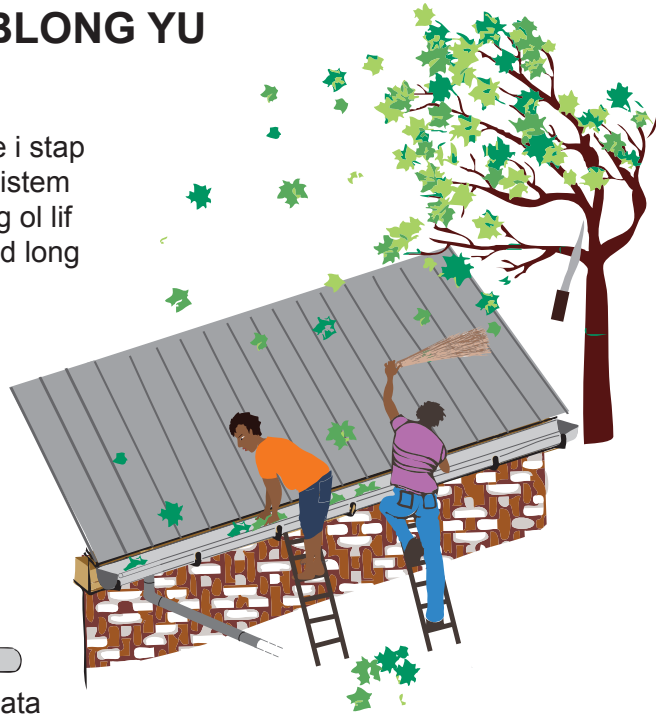

Wasem gata blong yu evri 3 manis mo karem aot ol toti.



Wasem tank wetem sop mo brum insaed long tank blong yu afta saeklon mo evri yea o taem hemi empti.



No putum tank i ko daon long saed blong wasem hem.



Wasem gud moskito net afta saeklon mo eni bigfala win from hemi toti.

# OL SEVEN STAMBA TINGTING BLONG RED CROSS MO RED CRESCENT MUVMEN

## 1 Umaniti

International Red Cross mo Red Crescent Muvmen, we i bon from wan tingting blong givim help we i no gad discrimination long olgeta we ol i kasem kil, hemi faet long intansional mo nasional wok blong hem, blong stopem mo daonem wei we laef blong man i stap safa long hem. Hemi i blong promotem undastanding, frensip, koperesen we ol i serem mo pis we i save last long metel blong evri man.

## 2 Impasialiti

Hem i nogat discriminasion long saed blong nasionaliti, res, bilif, long joj, klas o politikel tingting. Hemi i wok strong blong stopem fasin we man i stap safa long hem nomo mo givim fesfala janis long olgeta keis blong trabol we oli nidim kwik help.

## 3 Niutraliti

Fasin blong no tekem part blong eni saed. Blong mekem se hem i gat strong tingting blong evri man oltaem, muvmen ia i no save tekempat long eni faet, o joen long eni taem long rao long saed blong politik, res, joj o aedia.

## 4 Indipendens

Muvmen ia hemi Indipenden. Eni wok we Red Cross i mekem i folem nomo ol stamba tingting blong hem mo i no folem tingting blong nara man o organisesen.

## 5 Volontari Seves

Muvmen ia hemi wan volontari organisesen blong givim help we hemi no redi blong winim mani long saed blong olgeta wok blong hem.

## 6 Uniti

Long eni kaontri i save gat wan Red Cross o Red Crescent Society nomo mo hem i mas open long evri man. Hemi i mas mekem olgeta wok blong hem long saed blong laef blong man olbaot long kaontri blong hem.

## 7 Universaliti

Wok Raon long Wol. International Red Cross mo Red Crescent Muvmen, hem i wan bodi we man i save faenem olbaot long wol. Evri sosaeti oli gat semfala kondisen we oli serem olgeta semfala responsibiliti mo wok blong helpem wanwan long olgeta.

*Long 1965 oli apruvum ol Seven Bigfala loa blong Red Cross we oli stamba blong ol work blong muvmen ia.*

*From strong tingting we Red Cross i gat, hemi stap singaot strong long evri men mo women o yut we oli gat gudfala hat mo we oli no kae long wanem kaen pipol, wanem kaen level mo wanem kaen joj o biliv nao oli stap dil wetem.*

*Hemia nao kontribusion blong hem long saed blong PIS long world.*

Ren Wota hem i gud blong trink !  
Taem yu save instalem tank blong  
hem, yu save givim safe wota long  
famili mo fren blong yu.



**Umaniti**

**Impasialiti**

**Niutraliti**

**Indipendens**

**Volontari Seves**

**Uniti**

**Universaliti**

Blong kontaktem Vanuatu Red Cross Society :  
PO Box 618 - Port-Vila, Vanuatu  
email : [redcross@vanuatu.com.vu](mailto:redcross@vanuatu.com.vu)  
website : [www.redcross.org.vu](http://www.redcross.org.vu)  
tel. +678 27418 fax +678 22599